



**ONE** -Stop Solution Service;

Products made by DYS own factory with competitive price,  
good quality and fast delivery time.



**FTTX Series**

**SHENZHEN DYS FIBER OPTIC TECHNOLOGY CO.,LTD**

Tel: 86-0755-29650336 Fax: 86-0755-29510505 Mail: [dys@dysfiber.com](mailto:dys@dysfiber.com)

Headquarters: 2/F,7Building,TangTou Industrial Zone 3rd,shiyang Town,BaoAn District,Shenzhen,P.R.China

ShenZhen Factory: 2/F,7Building,TangTou Industrial Zone 3rd,shiyang Town,BaoAn District,Shenzhen,P.R.China

MianYang Factory: 3rd,Wu Tong Villages,WuDuo Town,JiangYou City,SiChuan Province,P.R.China

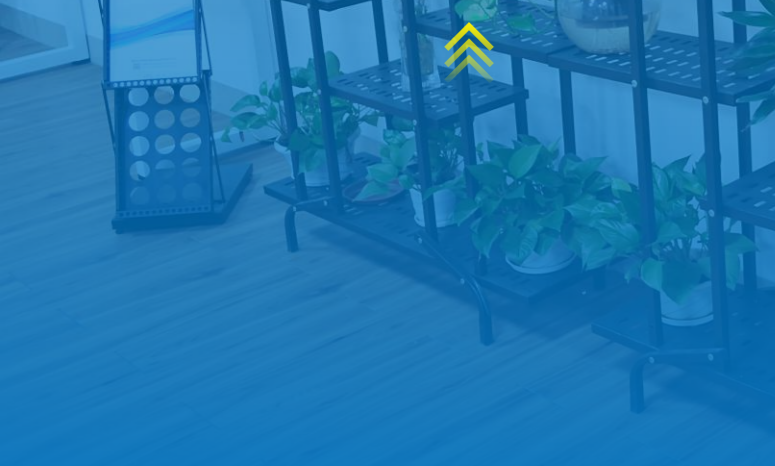

# contents

## contents

### PROFILE COMPANY

Shenzhen DYS Fiber Optic Technology is a leading company in developing and manufacturing advanced fiber optic products, mainly make fiber optic indoor and outdoor cable, CPRI waterproof jumper, MPO/MTP jumper , standard fiber optic jumper and PLC Splitter. DYS win the honorary title of National High-tech enterprise by Shenzhen government in 2014.

With years of experiences in the fiber optic industry, our factory is fully equipped over 3500 square meters and more than 18 non dust production lines .About 200 well-trained staff and engineers are contributing to our proud products. We have 5 production lines for fiber optic cable, 2 high standard MPO/MTP jumper assembly lines, 8 production lines for standard jumper and 8 PLC Splitter production lines.

The most advanced imported polishing equipment and testing instruments enable our products have super quality, such as Senko polishing machine, interferometer, automatic cleaning machine and OTDR ,JGR and so on.

All of our optical products are RoHS compliant and DYS also obtained ISO9001, ISO14001 certification. Our high quality products and outstanding service win the customer from all the world, DYS fiber optic is looking forward to cooperate with you.

### OUR ADVANTAGE

01 ONE-Stop Solution Service;

02 Products made by DYS own factory with competitive price, good quality and fast delivery time.

CPRI LC Outdoor Cable Assemblies	-----	1
NSN(LC) Outdoor Cable Assemblies	-----	2
FULLX(LC) Outdoor Cable Assemblies	-----	3
IPFX Outdoor Cable Assemblies (SC,LC,MPO)	-----	4
ODVA Outdoor Cable Assemblies (SC,LC,MPO)	-----	5
AARC Outdoor Cable Assemblies	-----	6
PDLC Outdoor Cable Assemblies	-----	7
H optic(SC/APC) Outdoor Cable Assemblies	-----	8
IPSCAPC Outdoor Cable Assemblies	-----	9
FTTH Flat Drop Patch Cord	-----	10
FTTH Round Pigtail	-----	11
PLC Splitter	-----	12
Fast Connector	-----	13
SC Auto Shutter Connector & Adapter	-----	14
FTTH Terminal Box	-----	15-16
FTTX Enclosure	-----	17-18
Why Choose DYS Fiber Optic	-----	19
Major Equipment	-----	20

## CPRI LC Outdoor Cable Assemblies **FTTA**

### Applications

- Multi-purpose Outdoor
- For connection between distribution box and RRH
- Deployment in Remote Radio Head cell tower applications

### Features

- Easily add/install jumper cables for a future expansion
- Factory-assembled cables for a fast on-site installation
- IP67 water and dust protection
- Flexibility with small bending radius and excellent cable routing properties
- Equipped with customer specific power and fiber-optic connectors



### Cable Structures



### Product Parameters

Type	SM-UPC		SM-APC		MM-UPC	
	Typical	MAX	Typical	MAX	Typical	MAX
Insertion Loss:	≤0.1	≤0.3dB	≤0.15	≤0.3dB	≤0.05	≤0.3dB
Return Loss:	≥50dB		≥60dB		≥30dB	
Durability:	500 mating cycles					
Working Temperature:	-40 to +85°C					

## NSN boot dulex LC Fiber Optic Jumper (Remote Radio Head) **FTTA**

### Applications

- Multi-purpose Outdoor
- For connection between distribution box and RRH
- Deployment in Remote Radio Head cell tower applications

### Features

- IP67 water and dust protection
- Capacity 1 to 3 fiber pairs, LC connector or vendor specified connector
- Corrugated steel armor or non armor
- Outer sheath of UV resistant
- Temperature range -40°C to +80°C



### Cable Structures



### Product Parameters

Type	SM-UPC		SM-APC		MM-UPC	
	Typical	MAX	Typical	MAX	Typical	MAX
Insertion Loss:	≤0.1	≤0.3dB	≤0.15	≤0.3dB	≤0.05	≤0.3dB
Return Loss:	≥50dB		≥60dB		≥30dB	
Durability:	500 mating cycles					
Working Temperature:	-40 to +85°C					

## FULLX(LC) Outdoor Cable Assemblies

FTTA

### Applications

- Multi-purpose Outdoor
- For connection between distribution box and RRH
- Deployment in Remote Radio Head cell tower applications

### Features

- Open bulkhead for easy access to SFP
- IP67 water and dust protection
- Bulkhead cutout allows for removal of transceiver through the bulkhead
- No need to open remote radio head (RRH) for transceiver replacement
- Water proof, dust proof and corrosion resistant
- Plug has tolerance free design, free floating on Z-axis



### Cable Structures



### Product Parameters

Type	SM-UPC		SM-APC		MM-UPC	
	Typical	MAX	Typical	MAX	Typical	MAX
Insertion Loss:	≤0.1	≤0.3dB	≤0.15	≤0.3dB	≤0.05	≤0.3dB
Return Loss:	≥50dB		≥60dB		≥30dB	
Durability:	500 mating cycles					
Working Temperature:	-40 to +85°C					

## IPFX Outdoor Cable Assemblies (SC,LC,MPO)

FTTA

### Applications

- Multi-purpose Outdoor
- For connection between distribution box and RRH
- Deployment in Remote Radio Head cell tower applications

### Features

- Factory terminated (tested cables) or Field installable version available
- Pre-fitted with the IPFX receptacle
- Water proof, dust proof
- IP67 water and dust protection
- Designed to meet 150N cable retention



### Cable Structures



### Product Parameters

Type	SM-UPC		SM-APC		MM-UPC	
	Typical	MAX	Typical	MAX	Typical	MAX
Insertion Loss:	≤0.1	≤0.3dB	≤0.15	≤0.3dB	≤0.05	≤0.3dB
Return Loss:	≥50dB		≥60dB		≥30dB	
Durability:	500 mating cycles					
Working Temperature:	-40 to +85°C					

## ODVA Outdoor Cable Assemblies (SC,LC,MPO)

FTTA

### Applications

- Multi-purpose outdoor
- For connection between distribution box and RRH
- Deployment in remote radio head cell tower applications

### Features

- Cost effective solution for in house termination
- IP67 water and dust protection
- Wide range of operational temperature for outside plant -40
- Different cable diameter can be available
- Intermatable to other Industrial LC adaptor per IEC 61076-3-106
- No need special tools for assembly



### Cable Structures

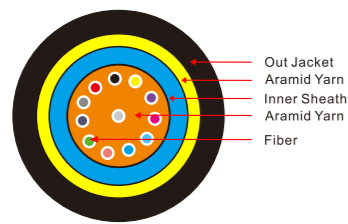

4.8mm

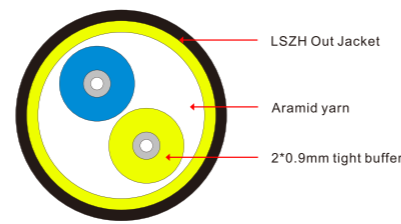

5.0mm

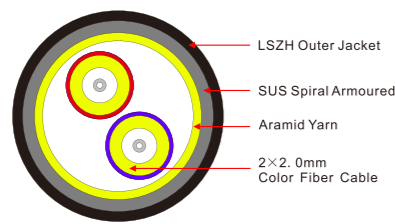

7.0mm SUS Spiral Armoured

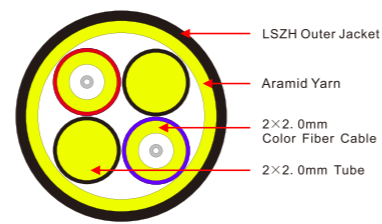

7.0mm

### Product Parameters

Type	SM-UPC		SM-APC		MM-UPC	
	Typical	MAX	Typical	MAX	Typical	MAX
Insertion Loss:	≤0.1	≤0.3dB	≤0.15	≤0.3dB	≤0.05	≤0.3dB
Return Loss:	≥50dB		≥60dB		≥30dB	
Durability:	500 mating cycles					
Working Temperature:	-40 to +85°C					

## AARC Outdoor Cable Assemblies

FTTA

### Applications

- Multi-purpose Outdoor
- For connection between distribution box and RRH
- Deployment in Remote Radio Head cell tower applications

### Features

- Bird proof and rodent resistant
- IP67 water and dust protection
- Available with singlemode or multimode fiber
- Flange, Jam-Nut, or In-Line type receptacle assemblies
- Operating temperature: -40° to 85°C
- RoHS compliant



### Cable Structures

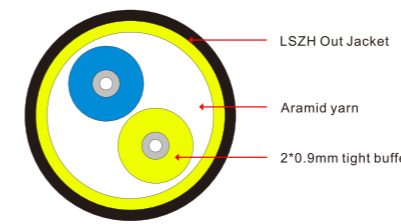

4.8mm

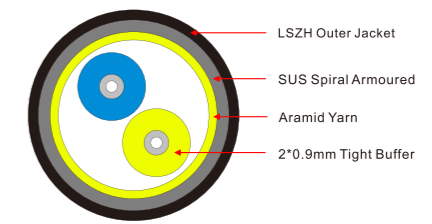

4.8mm SUS Spiral Armoured

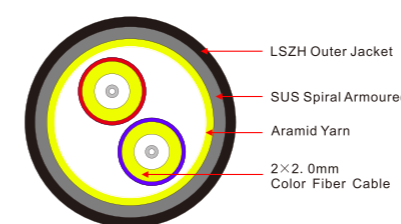

7.0mm SUS Spiral Armoured

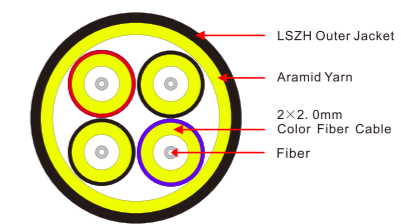

7.0mm

### Product Parameters

Type	SM-UPC		SM-APC		MM-UPC	
	Typical	MAX	Typical	MAX	Typical	MAX
Insertion Loss:	≤0.1	≤0.3dB	≤0.15	≤0.3dB	≤0.05	≤0.3dB
Return Loss:	≥50dB		≥60dB		≥30dB	
Durability:	500 mating cycles					
Working Temperature:	-40 to +85°C					

## PDLC Outdoor Cable Assemblies

FTTA

### Applications

- Multi-purpose Outdoor
- For connection between distribution box and RRH
- Deployment in Remote Radio Head cell tower applications



### Features

- Standard DLC connector, well connected with standard LC adaptor
- Available Single mode and Multimode
- IP67 water and dust protection
- compact design
- Broad temperature range and wide range of indoor and outdoor cables
- Easy Operation, reliable and cost-effective installation

### Cable Structures

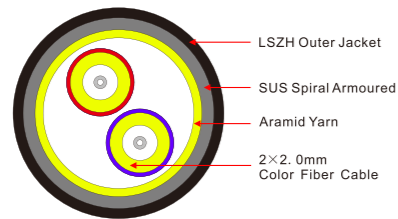

7.0mm SUS Spiral Armoured

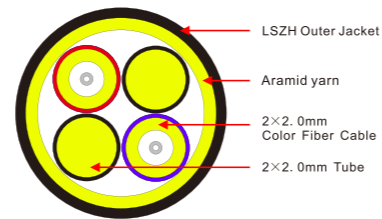

7.0mm

### Product Parameters

Type	SM-UPC		SM-APC		MM-UPC	
	Typical	MAX	Typical	MAX	Typical	MAX
Insertion Loss:	≤0.1	≤0.3dB	≤0.15	≤0.3dB	≤0.05	≤0.3dB
Return Loss:	≥50dB		≥60dB		≥30dB	
Durability:	500 mating cycles					
Working Temperature:	-40 to +85°C					

## H optic(SC/APC) Outdoor Cable Assemblies

FTTH

### Applications

- FTTH
- Outdoor Areas
- Harsh Environment



### Features

- Single fiber, SC-based connector
- Bird proof and rodent resistant
- IP67 water and dust protection
- Low profile in-line receptacle available
- No installation tools required
- In-line connection available
- Cable diameter Range: 2.0mm, 3.0mm, 4.8mm to 7mm

### Cable Structures

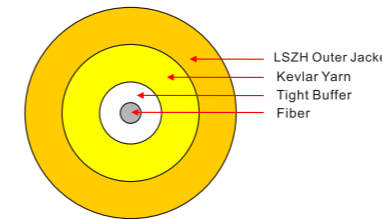

3.0mm



5.0mm

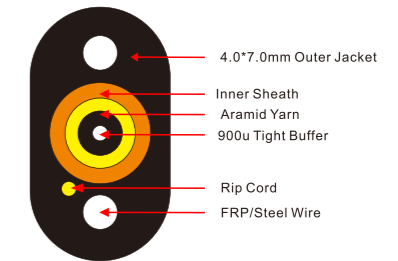

4.0\*7.0mm

### Product Parameters

Type	SM-UPC		SM-APC		MM-UPC	
	Typical	MAX	Typical	MAX	Typical	MAX
Insertion Loss:	≤0.1	≤0.3dB	≤0.15	≤0.3dB	≤0.05	≤0.3dB
Return Loss:	≥50dB		≥60dB		≥30dB	
Durability:	500 mating cycles					
Working Temperature:	-40 to +85°C					

## IPSCAPC Outdoor Cable Assemblies

FTTH

### Applications

- Fiber optic communications in harsh outdoor environments
- Outdoor communication equipment connection
- waterproof fiber equipment SC port
- Remote wireless base station
- FTTx wiring project

### Features

- compact size, easy to operate, durable
- Easy connection to hardened adapters on terminals or closures
- Reduce welding, connect directly to achieve interconnection
- IP67 water and dust protection
- Spiral clamping mechanism ensures long-term reliable connection
- Guide mechanism, can be blinded with one hand, simple and quick, connect and install
- Seal design: It is waterproof, dust-proof, anti-corrosion and so on.



### Cable Structures

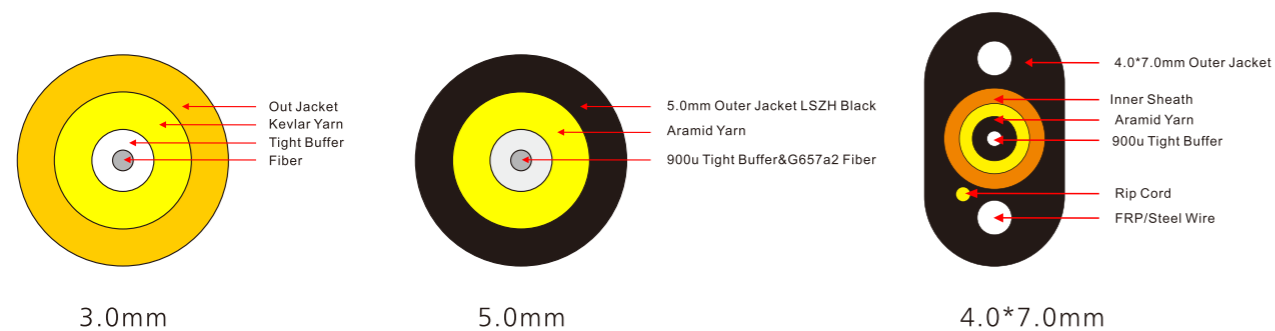

### Product Parameters

Type	SM-UPC		SM-APC		MM-UPC	
	Typical	MAX	Typical	MAX	Typical	MAX
Insertion Loss:	≤0.1	≤0.3dB	≤0.15	≤0.3dB	≤0.05	≤0.3dB
Return Loss:	≥50dB		≥60dB		≥30dB	
Durability:	500 mating cycles					
Working Temperature:	-40 to +85°C					

## FTTH Flat Drop Patch Cord

FTTH

### Applications

- FTTH network for indoor and outdoor
- Local Area Network and Building Cabling Network
- Interconnect between instruments, terminal box and communication

### Features

- Low insertion loss, high return loss
- Available FTTH Drop cable diameters: □2.0\*5.0mm; □2.0\*3.0mm
- Connector Types: LC, FC, SC,ST for option
- Fiber Mode: G652D, G.657A1, G657A2, G657B3
- Ferrule Interface Type: UPC to UPC, APC to APC, APC to UPC
- Compliant to IEC standard



### Cable Structures

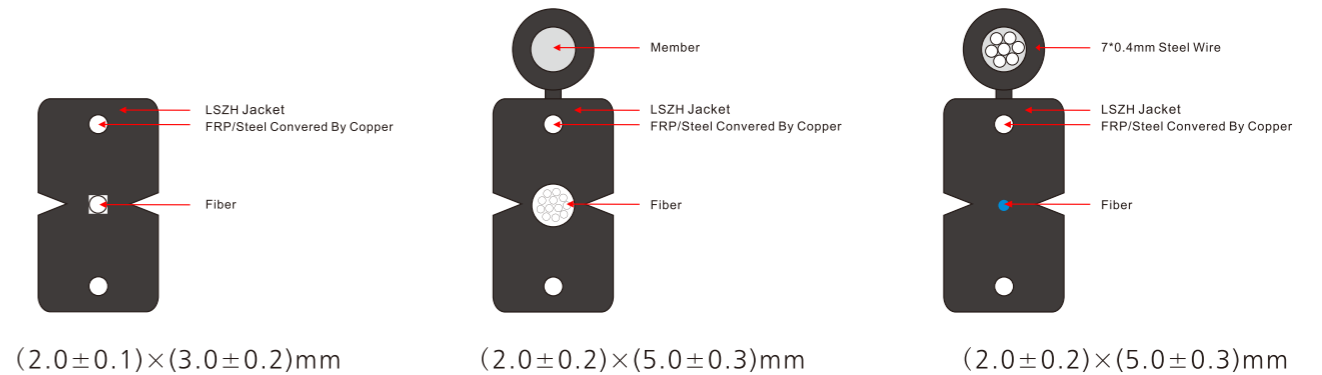

### Product Parameters

Type	SM-UPC		SM-APC		MM-UPC	
	Typical	MAX	Typical	MAX	Typical	MAX
Insertion Loss:	≤0.1	≤0.3dB	≤0.15	≤0.3dB	≤0.05	≤0.3dB
Return Loss:	≥50dB		≥60dB		≥30dB	
Durability:	500 mating cycles					
Working Temperature:	-40 to +85°C					

## FTTH Round Pigtail

FTTH

### Applications

- CATV
- Telecom network
- Optical test equipment
- Local area network
- Wide area network
- Data processing network

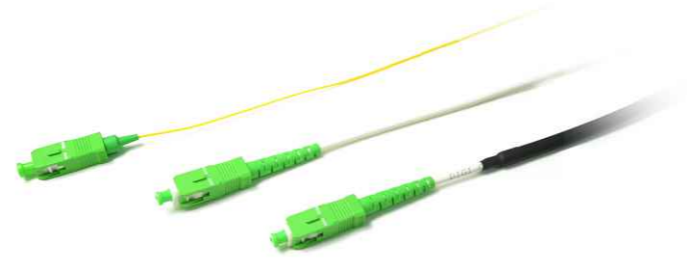

### Features

- Connector cleaning instructions included in each bag of 900 μm pigtails
- Individual packaging and labelling provides protection, performance data and traceability
- 12 fibre, 3 mm round mini cable pigtails available for high density splicing
- 4.6/5.0mm double sheath cable pigtails available for waterproof connector (MINI SC, OptiTap, Hoptic)

### Cable Structures

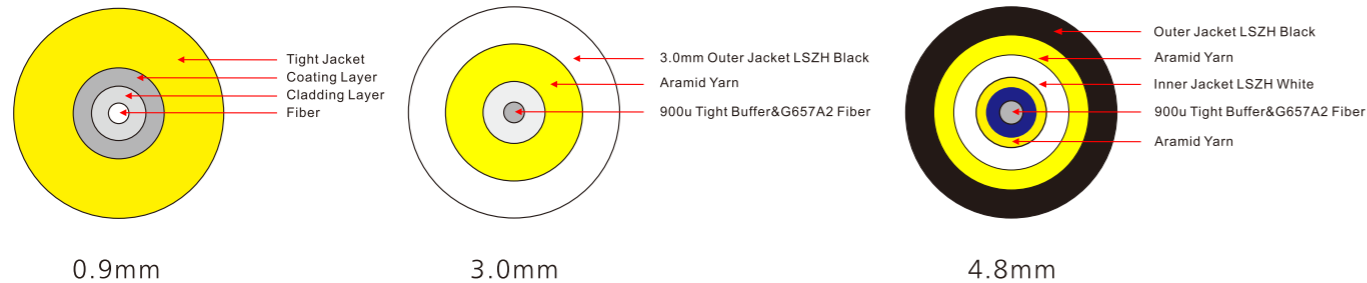

### Product Parameters

Type	SM-UPC		SM-APC		MM-UPC	
	Typical	MAX	Typical	MAX	Typical	MAX
Insertion Loss:	≤0.1	≤0.3dB	≤0.15	≤0.3dB	≤0.05	≤0.3dB
Return Loss:	≥50dB		≥60dB		≥30dB	
Durability:	500 mating cycles					
Working Temperature:	-40 to +85°C					

## PLC Splitter

FTTH

### Applications

- FTTx Systems
- Digital, hybrid and AM-Video systems
- LAN,WAN and Metro Networks
- CATV systems
- Other applications in fiber optic systems



### Features

- Low Insertion loss and Low PDL
- Uniform power splitting
- High reliability
- Excellent environmental stability
- Compact size and various package

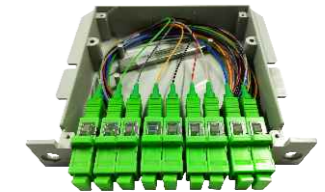
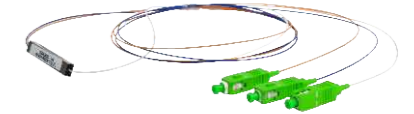

### Product Parameters

Parameter/Type	Nx2(N=1or2)	NX4(N=1or2)	NX8(N=1or2)	NX16(N=1or2)	NX32(N=1or2)	NX64(N=1or2)
Fiber	9/125 um SMF-28e or customer appoint					
Operating Wavelength(nm)	1260~1650(nm)					
Insertion Loss	≤3.9dB	≤7.1dB	≤10.3dB	≤13.3dB	≤16.3dB	≤19.8dB
Loss Uniformity(dB)	≤0.6dB	≤0.6dB	≤0.8dB	≤1.2dB	≤1.5dB	≤2.0dB
Polariation Dependent Loss	≤0.15dB	≤0.15dB	≤0.2dB	≤0.2dB	≤0.2dB	≤0.3dB
Return Loss	UPC≥50dB APC≥60dB					
Directivity	≥55dB					
Working Temperature(°C)	-40°C to +85°C					

## Fast Connector

FTTH

### Applications

- Used to open the FTTH fiber terminal end.
- In the box, cabinet, such as wiring into the box.
- Off the back of the accidents such as fiber, maintenance.
- LAN, wan, data and video transmission.
- The construction of the fiber end user access and maintenance.
- Optical fiber access of mobile base station.



### Features

- Single fiber, SC/LC/ST/FC-based connector
- In-line connection available
- Operating temperature: -40° to 85°C
- Cable Diameter Range: 2.0mm, 3.0mm, 2.0\*3.0mm



manual



tool



10pcs



100pcs

### Product Parameters

Type	SM-UPC		SM-APC		MM-UPC	
	Typical	MAX	Typical	MAX	Typical	MAX
Insertion Loss:	≤0.1	≤ 0.35dB	≤0.15	≤ 0.35dB	≤0.05	≤ 0.3dB
Return Loss:	≥45dB		≥55dB		≥30dB	
Durability:	500 mating cycles					
Working Temperature:	-40 to +85°C					

## SC Auto Shutter Connector&Adapter

FTTH

### Applications

- Optical fiber communication systems engineering.
- Fiber optic data communication network.
- Fiber CATV, FTTH engineering.
- Other optical technology tests.

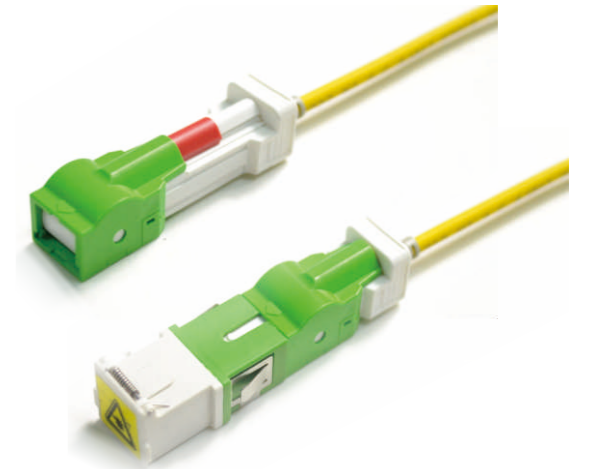

### Features

- Low insertion loss and added loss.
- High stability, high reliability, height of attenuation.
- High back loss, small volume, light weight.
- Shutters open and close automatically .
- SC Auto-door connector can be used with a regular SC adapter .
- Offers highest level of dust and laser protection available.
- Connector design conforms to human engineering, easy to handle.
- Suitable for optical cable diameter:2. 0mm, 3. 0mm.
- Meets with RoHS and reach.

### Product Parameters

Type	SM-UPC		SM-APC		MM-UPC	
	Typical	MAX	Typical	MAX	Typical	MAX
Insertion Loss:	≤0.1	≤ 0.3dB	≤0.15	≤ 0.3dB	≤0.05	≤ 0.3dB
Return Loss:	≥50dB		≥60dB		≥30dB	
Durability:	500 mating cycles					
Working Temperature:	-40 to +85°C					

## FTTH Terminal Box FTTH

### Applications

- Fiber to the home (FTTH)
- Fiber to the building (FTTB)
- Local area networks
- Wide area networks

### Features

- Small size and light weight for easy installation compact body.
- Easy installations: Ready for wall mount – installation kits provided.
- Lower layer for splicing .
- Upper layer for cross-connecting and fiber distribution.
- Fully stable adapter panel, no risk of movement.
- Fiber can get in from bottom or side

	
Dimension (W*H*D)	200mm(W)x215mm(H)x54mm(D)
DYS Part Number	FTTH - 004 / 8Core
	
Dimension (W*H*D)	260mm(W)x320mm(D)x95mm(D)
DYS Part Number	FTTH - 005 / 16Core
Material	ABS

	
Dimension (W*H*D)	86mm(W)x86mm(H)x23mm(D)
DYS Part Number	FTTH - 006 / 2Core
	
Dimension (W*H*D)	210mm(W)x140mm(H)x40mm(D)
DYS Part Number	FTTH - 015 / 6Core
	
Dimension (W*H*D)	80mm(W)x100mm(H)x23mm(D)
DYS Part Number	FTTH - 016 / 2Core
	
Dimension (W*H*D)	100mm(W)x83mm(H)x32mm(D)
DYS Part Number	FTTH - 019 / 4Core
	
Dimension (W*H*D)	116mm(W)x86mm(H)x23mm(D)
DYS Part Number	FTTH - 022 / 2Core
Material	ABS

## FTTX Enclosure

### FTTX

### Applications

- FTTH field
- FTTA field
- Trunk cable connecting
- Prospecting or military communication



### Features

- High compatibility: can be assembled ODVA, hconn(OptiTap compatible), Mini SC, ODC, PTLC, PTMPO or power adapter.
- Factory-sealed or field assembly.
- IP67 water and dust protection
- Strong enough: working under 1200N pulling force long term.
- From 2 to 12 ports for single or multifiber harsh connectors.
- Available with PLC or splice sleeve for fiber divide .
- IP67 waterproof rating.
- Wall-mounting, aerial installation or holding pole installation.
- Decreased angle surface and height make sure no connector interfering when operating.
- Meet IEC 61753-1 standard.
- Cost effective: save 40% operating time.

### Product Parameters

Dimensions(LxWxH)	365x137x90mm(Without cover) 375x142x120mm(With cover)
Ingress Protection	IP67
Working Temperature	-40~85°C
Cable Strength Member	Armoured or Non-armoured
Cable Type	Hybrid or non-hybrid
Round Cable OD	5.0mm to 14.0mm
Flat Cable Dimension	4.6x8.9mm
Cable Jacket Material	LSZH,PE or TPU
Bending Radius	20D
Cable Crush Resistance	200N/cm long term
Tensile Strength	1200N long term
UV Resistance	ISO 4892-3
Fire Protection Rating	UL94-V0
Number of PLC	1to 2pcs
Number of Fusion Protection Steeve	1to 24pcs

FTTX Enclosure is a new economic fiber distributed solution for outdoor use. compare traditional products, FTTX Enclosure is easy to operate and has high compatibility. It can be used for wall-mounting, aerial installation or holding pole installation, based on different situation. FTTX enclosure not only used in FTTH field, but also used in FTTA or other harsh environment.

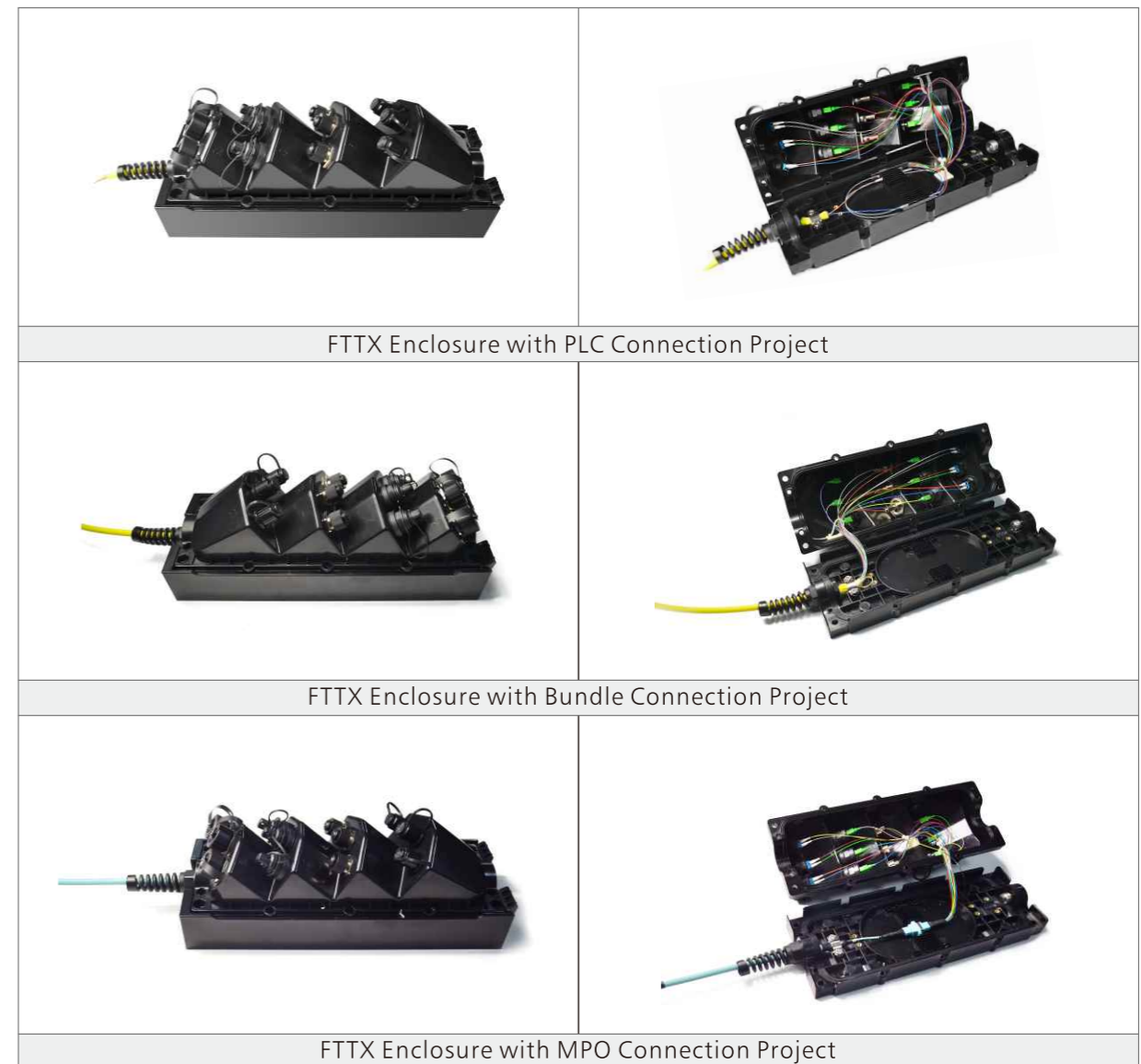

FTTX Enclosure with PLC Connection Project

FTTX Enclosure with Bundle Connection Project

FTTX Enclosure with MPO Connection Project



## WHY CHOOSE DYS FIBER OPTIC

### GOOD QUALITY

We strongly believe that product quality and performance are the key success factors of a company. This mindset has been rooted throughout the whole organization, everybody believes that only high standards are necessary to win the customer and market.

### INNOVATIVE TECHNOLOGY

We always learn new technology by investing in production facilities, engineering process control systems, and talent development to maintain our status as a leading fiber optic connection solutions.

### HIGH STANDARD

We believe a high standard of professionalism towards our product and service offerings combined with our superior engineering solutions serve to satisfy the unique needs of our customers.



Major Equipment

ISO9001-2015